



EVINRUDE[®]
OUTBOARDS



21929

Recommended Lubricant

ENGLISH

Use *Evinrude® Outboard Lubricant* or *OMC® 2-Cycle Motor Oil*, which are *NMMA*-certified for service *TC-W II*. These lubricants are formulated to give best engine performance with least combustion chamber deposits, least piston varnish, maximum spark plug life, and best lubrication.

Always keep an ample supply of the recommended lubricant on hand. Additives such as tune-ups, tonics, or friction reducing compounds should not be used in your engine.

If *Evinrude Outboard Lubricant* or *OMC 2-Cycle Motor Oil* is not available, another *NMMA*-certified *TC-W II* lubricant may be used. Look for the certification information on the container label.

Note Failure to use a *TC-W II* certified lubricant could void your warranty.

High performance boaters should use *Evinrude XP™ High Performance Lubricant*. This custom blended outboard lubricant is *TC-W II* certified and is specially formulated for the extra stress of the high performance outboard.

See your *Evinrude* DEALER for *OMC Systematched™* accessories and lubricant engineered specifically for use with your *Evinrude* outboard.

Refer to the **Fuel and Oil** section of this manual before operating this motor. If you have any questions, please contact your DEALER.

Lubricante Recomendado

ESPAÑOL

Use el aceite *Evinrude® Outboard Lubricant* o el aceite *OMC® 2-Cycle Motor Oil*, los cuales son aprobados por la *NMMA* para *TC-W II*. Estos aceites fueron formulados para proporcionar el mejor rendimiento del motor con un mínimo de depósitos en la cámara de combustión; la mínima acumulación de barniz en los pistones; máxima duración de las bujías y la mejor lubricación.

Mantenga siempre a mano una buena cantidad del lubricante recomendado. Los aditivos, tales como, afinadores, tónicos, compuestos que reducen la fricción, no deberán ser usados en su motor.

Si el aceite *Evinrude Outboard Lubricant* o el aceite *OMC 2-Cycle Motor Oil* no están disponibles, otro lubricante *TC-W II* aprobado por la *NMMA* podrá ser usado. Busque en el rótulo de la lata, la información sobre la clasificación y la aprobación del aceite.

Nota El no utilizar el lubricante aprobado *TC-W II*, podrá anular su garantía.

Los entusiastas en la navegación de alto rendimiento deberán usar el aceite *Evinrude XP™ High Performance Outboard Lubricant*. Este lubricante para motores fuera de borda es aprobado para *TC-W II* y fue formulado especialmente para cumplir con las exigencias adicionales de lubricación de los motores fuera de borda de alto rendimiento.

Vea a su AGENTE *Evinrude* para obtener los lubricantes y los accesorios *OMC Systematched™* que fueron diseñados específicamente para su motor fuera de borda *Evinrude*.

Antes de operar este motor, refiérase a la sección de **Combustible y Aceite** de este manual. Si Usted tiene alguna pregunta, póngase en contacto con su AGENTE.

Read this manual thoroughly before attempting to operate your outboard.

GENERAL INFORMATION



FEATURES

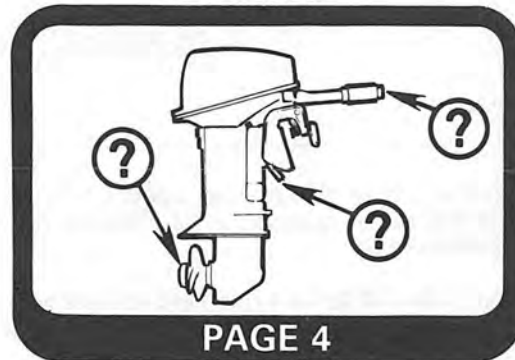

FUEL AND OIL

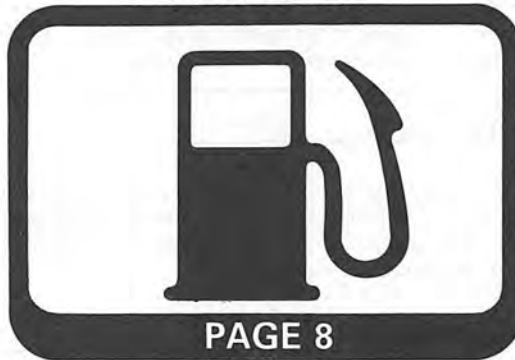

STARTING

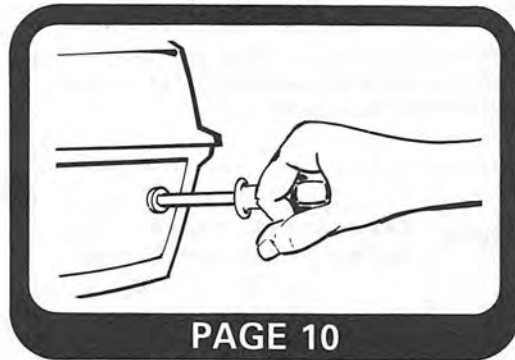

OPERATION

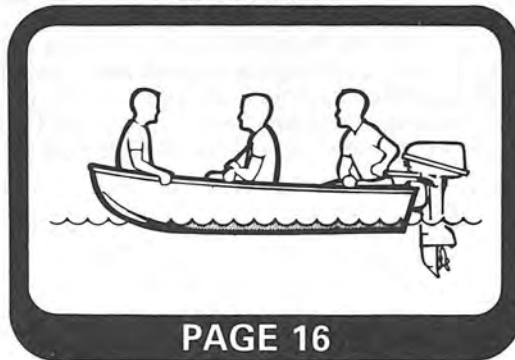

MAINTENANCE

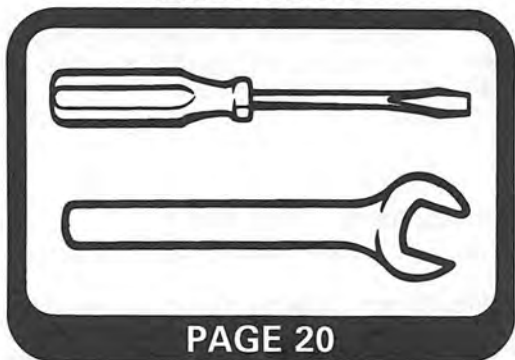

INSTALLATION

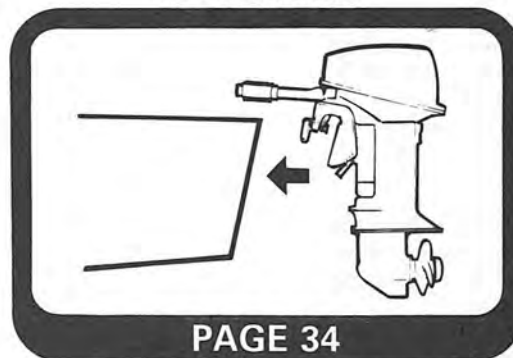

© Outboard Marine Corporation 1990. All rights reserved.





GENERAL INFORMATION

Modifications

The warranty at the end of this manual applies to your motor only when the motor is used for its intended purpose. **READ IT CAREFULLY.**

If you modify your outboard motor to increase performance or if you use it in sanctioned racing, your motor has **NO WARRANTY.**

Safety

This manual contains information that can help prevent personal injury and damage to equipment. Understand the following symbols before proceeding:

 Safety Warning	Alerts you to the possibility of danger and identifies information that will help prevent injuries.
Note	Identifies information that will help prevent damage to machinery.
Important	Appears next to information that controls correct assembly and operation of the product.

Product References, Illustrations and Specifications

! Safety Warning: When replacement parts are required, use genuine OMC parts, or parts with equivalent characteristics, including type, strength and material. Use of substandard parts could result in product failure and personal injury.

Outboard Marine Corporation reserves the right to make changes at any time, without notice, to features, specifications, and model availability. The right is also reserved to change any specification or part at any time without incurring any obligation to update older models. The information in this manual is based on the latest specifications available at the time of publication.

Photographs and illustrations used in this manual may not depict actual models or equipment, but are intended as representative views for reference only. The continuing accuracy of this manual cannot be guaranteed.

Certain features or systems discussed in this manual might not be found on all models in all marketing areas.

Illustration Symbols

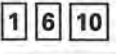
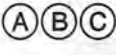
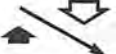
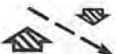
	Refer to the photo or drawing described by that paragraph.
	Refer to specific items or features described in the text and illustrated in the photo.
	Refer to the general subject of the text.
	Refer to an item or feature that is not clearly visible in the photo.

Service Literature

A service manual, parts catalog or extra owner's manual may be purchased from Outboard Marine Corporation. Use the order form provided in the English language owner's manual or see your DEALER.

Extended Warranty

OMC 1+2™ Extended Protection Plan is available through your DEALER. The Plan must be purchased during your engine's first nine months of warranty. After a \$25 charge for each occurrence, the Plan covers costs of parts and labor in warranty situations during the second and third years of recreational engine ownership or during the second year of commercial engine ownership. See your DEALER for details or call *Outboard Marine Corporation* at (708) 689-6227.



Boat Horsepower Capacity _____

⚠ Safety Warning: Do not overpower your boat by using an engine that exceeds the horsepower indicated on the boat's capacity plate. Overpowering could result in loss of control. If boat has no capacity plate, contact your DEALER or the boat's manufacturer.

Boats designed specifically for tiller steered engines have special requirements for horsepower capacity. If you have any questions about the application of your motor, ask your DEALER or boat manufacturer.

Boater's Responsibilities _____

The operator is responsible for the correct operation of the boat and for the safety of its occupants. Make sure that all operators read this manual before operating the boat. Show your passengers the location of emergency equipment and explain how to use it. Be sure one of your passengers knows how to handle your boat in case of emergency. Requirements for personal flotation devices and other safety equipment vary depending on the type of boat. Always comply with the regulations that apply to your boat.

Basic Safety Rules of Boating _____

- Avoid standing up or shifting weight suddenly in small, lightweight boats.
- Keep boat occupants seated in seats, not on boat's bow, gunwale, transom, back of seat, or other part of boat not intended for use as a seat.
- Life preservers should be worn by all occupants when boating conditions are hazardous, and by children and non-swimmers at all times.
- Know the marine traffic laws and obey them.
- Prevent explosion and fire by thoughtfully choosing your fuel delivery system and maintaining it in top condition. Fuel vapor is volatile; handle fuel with care.
- Keep your boat and equipment neat and in prime operating condition. Carry a selection of spare parts for the engine.
- DON'T OPERATE BOAT IF YOU ARE UNDER THE INFLUENCE OF DRUGS OR ALCOHOL.

Owner's Identification _____

At the time you purchase your motor, your dealer will complete the motor registration form. The owner's portion of this form will provide proof of ownership and purchase date if warranty service is ever necessary. The procedure for motor registration will vary depending on your location. Contact your DEALER or distributor for details.

Model and Serial Numbers _____

The model and serial numbers appear on a plate attached to the stern bracket or swivel bracket.

Record specific information below:

Model Number _____

Serial Number _____

Ignition Key Number _____

Purchase Date _____

Stolen Motors _____

If your motor is stolen, report the loss, in writing, to the OMC Warranty Department, 3145 Central Avenue, Waukegan, Illinois 60085. Include the engine's model number, serial number, and purchase date in your report. Also, contact your insurance agent and the local authorities.

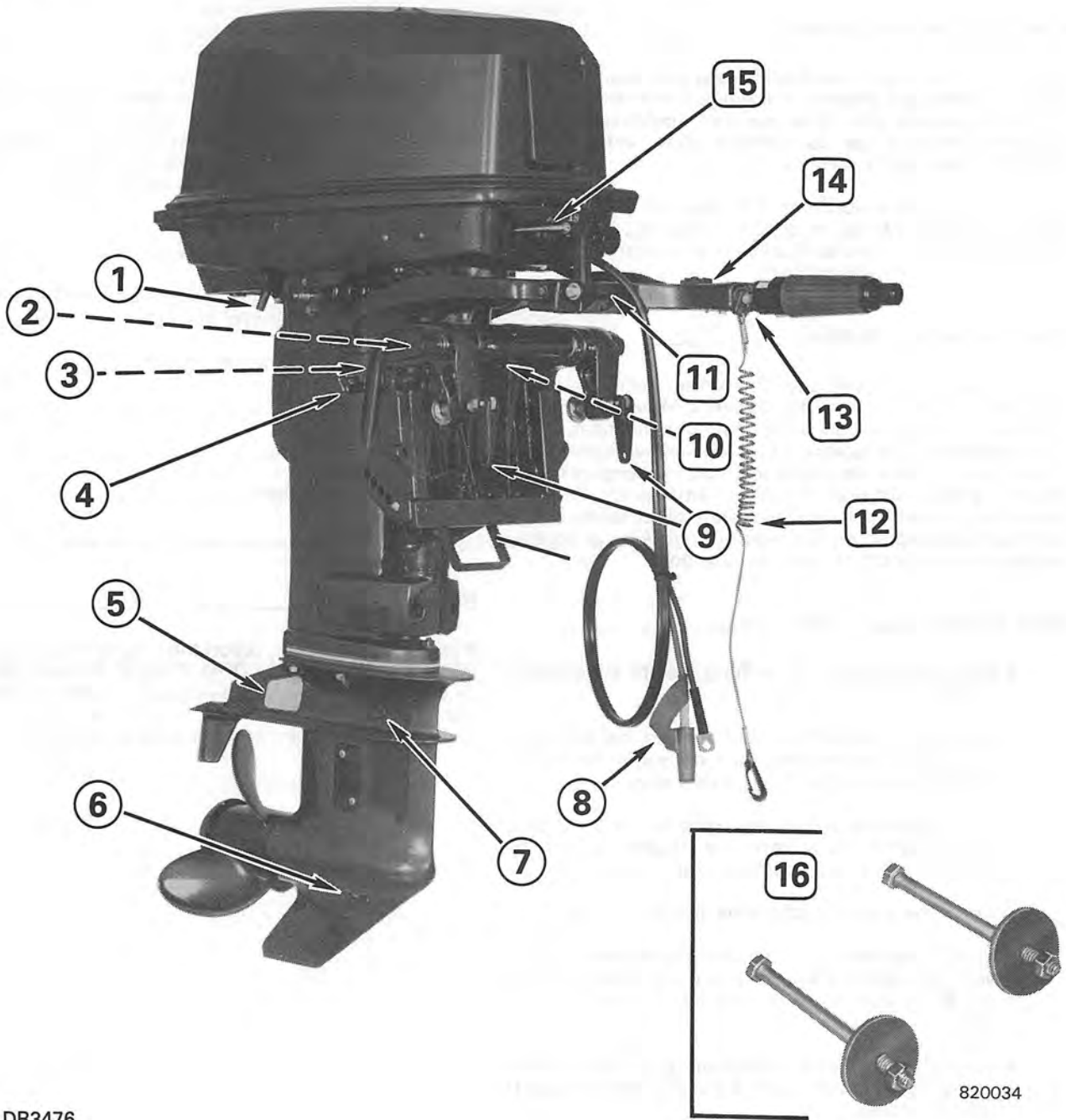
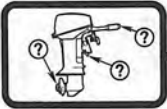

DR3476

820034

Item	Description	Page
①	Water Pump Indicator	12
②	Tilt Friction Nut (20/25)	21
③	Steering Friction Screw (30/35)	21
④	Tilt/Run Lever (30/35)	17
⑤	Anti-Corrosion Anode	24
⑥	Lube Drain/Fill Plug	22
⑦	Lube Level Plug	22
⑧	Electrical Cable (Electric Start Model) ...	33

Item	Description	Page
⑨	Clamp Screws	33
⑩	Steering Friction Screw (20/25)	21
⑪	Carrying Handle	34
⑫	Clip and Lanyard Assembly	6
⑬	Stop Switch and Emergency Stop Switch	6
⑭	Emergency Restart Clip	6
⑮	Start Button (Electric Start Model)	12
⑯	Mounting Hardware	33

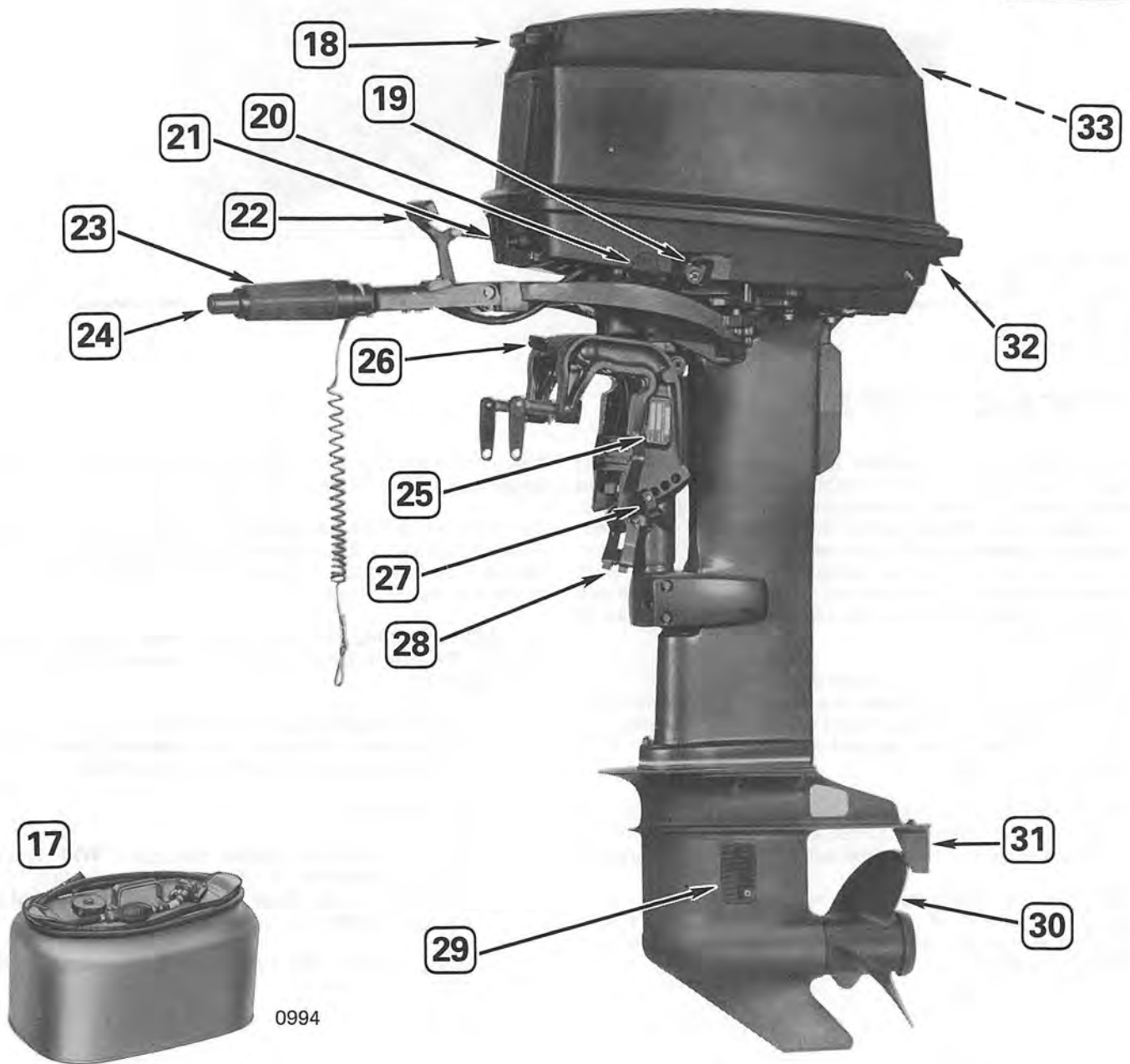
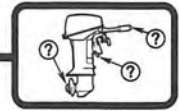

DR3477

Item	Description	Page
17	Fuel Tank	9
18	Starter Grip	12
19	Fuel Connector	11
20	A.C. Lighting Inlet (A.C. Lighting Model)	30
21	Primer Knob	12
22	Shift Lever	13
23	Steering Handle and <i>Twist-Grip™</i> Throttle	11
24	Idle Speed Adjusting Knob	21
25	Model and Serial Number Plate	3

Item	Description	Page
26	Tilt/Run Tab (20/25)	11
27	Motor Angle Adjusting Rod	19
28	Shallow-Water Drive Bracket	17
29	Water Intakes	18
30	Propeller	25
31	Trim Tab	23
32	Engine Cover Latch	14
33	Tilt Grip	16



24331

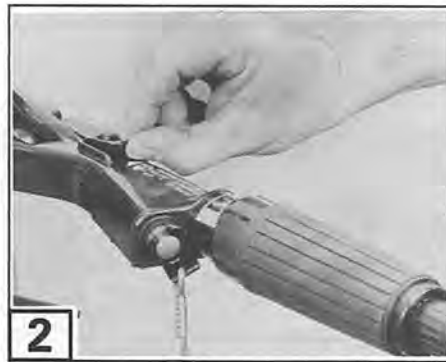

24188

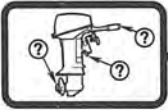

EMERGENCY STOP SWITCH

The Emergency Stop Switch is located on the steering handle bracket. Use of the switch is highly recommended on any boat considered to have sensitive steering response. Examples of such boats would include smaller runabouts, high performance sport boats, and bass boats. In addition an emergency stop switch should be used on any boat where the distance between the driver's seat cushion and the edge of the boat next to the seat cushion is less than 12 in. (305 mm).

1 Attach clip and lanyard to the emergency stop switch on the steering handle. Attach the lanyard to a secure place on clothing. Do not place lanyard on clothing that might be torn or will permit the lanyard to pull away rather than stopping the engine

Avoid knocking or pulling the clip and lanyard off during normal boating operation. Unexpected loss of forward motion could occur allowing occupants to be thrown forward.

Using the clip and lanyard will not interfere with normal operation. However, if the driver leaves the operator's area, the stop switch will stop the engine preventing the boat from becoming a runaway.

When not in use, hook the loose end of lanyard in the hole in lanyard clip. This will keep the lanyard neatly out of the way.

2 An extra clip for emergency restarting is attached to the steering handle. In an emergency start situation, this clip can be inserted in the emergency stop switch so that the motor can be restarted.

! Safety Warning: The emergency stop switch can only be effective if it is in good working condition. Check the following:

- Lanyard must always have freedom of movement and be away from any obstructions or entanglements which could hinder its operation.

Once a Month

- Inspect switch for proper operation. With engine running, removal of clip and lanyard must stop engine. If engine does not stop, see your DEALER for replacement of switch.
- Inspect lanyard for cuts, fraying, or worn clip. Replace if in doubt.



22690

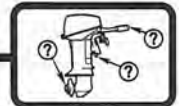

OMC Systematched™ Accessories

Because your boat is powered by an *Evinrude*® or *Johnson*® outboard, you already know about OMC's reputation as the world leader in marine power.

You may not know that OMC has developed a system of parts and accessories that integrates perfectly with an OMC-powered boat. It's called *OMC Systematched*.

Unlike someone else's parts and accessories, you don't have to worry about quality with OMC Systematched products. From impellers to propellers, fuel tanks to tachometers, these parts and accessories are designed by the same engineering team that designed your outboard. We manufacture them to the same strict engineering standards. That's a lot more than you can say about someone else's parts and accessories. Take *OMC Systematched* propellers, for example. They're specially designed to match the power curves of OMC engines. The result is optimum performance and fuel economy. No off-brand propeller can make that promise.

Our control cables are engineered for quick installation and top performance with *OMC Systematched* controls. Superior design and a patented liner lubrication process make *OMC Systematched* cables last longer and work more smoothly than any others.

Get the maximum performance from your OMC-powered boat. Specify *OMC Systematched* Parts & Accessories. And since OMC dealers are the only ones authorized to carry *OMC Systematched* products, you always know where to find them.

Choose *OMC Systematched* Parts & Accessories. Anything else is mismatched.

- **OIL** - OMC has developed a blend of mineral oil base stock and seven high quality ingredients for superior lubrication. *Evinrude*® and *Johnson*® lubricants are the benchmark for N.M.M.A.'s stringent TC-WII™ performance and durability rating.
- **INSTRUMENTS** - Several complete lines of instruments are available from OMC to monitor all your boat and engine systems. These instruments combine superior accuracy and state-of-the-art features to give you precise, dependable information.
- **PROPELLERS** - *OMC Systematched* propellers are specifically designed to match the power curves of OMC engines.
- **CONTROLS** - *OMC Systematched* controls provide for smooth, easy shifting.
- **CABLES** - Durable *OMC Systematched* control cables are designed to compliment our *OMC Systematched* controls for easy installation and smooth operation.



Fuel Octane	8
Oil	8
Fuel/Oil Ratios	8
Mixing Instructions	9
Fuel Systems	9

FUEL

Use any regular unleaded, regular leaded, or premium unleaded automotive gasoline that has not been extended with alcohol.

Use of alcohol extended fuels is acceptable **ONLY** if the alcohol content does not exceed:

- 10% Ethanol by volume
- 5% Methanol with 5% cosolvents by volume

Minimum Octane

Inside the U.S.	67 (R+M)/2 AKI
Outside the U.S.	69 RON

Note The use of premium grade fuels is specifically encouraged. Most national brand premium fuels contain detergent and dispersant ingredients advertised to reduce intake valve and fuel injector deposits. These ingredients also remove and prevent carbon buildup on pistons and rings. These ingredients can extend engine life while maintaining a high level of performance.

OMC products have been designed to operate using the above fuels, however, be aware of the following:

- The boat's fuel system may have different requirements regarding the use of alcohol fuels. Refer to the boat's owner manual.
- Alcohol attracts and holds moisture which can cause corrosion of metallic parts in the fuel system.
- Alcohol blended fuel can cause engine performance problems.
- All parts in the fuel system should be inspected frequently and replaced if signs of deterioration or leakage are found. Inspect at least annually.

⚠ Safety Warning: Fuel leakage can contribute to a fire or explosion.

Note OMC 2+4® fuel conditioner is the only gasoline additive approved by *Outboard Marine Corporation*. Use of other gasoline additives can result in poor performance or engine damage.

OIL

This is a two-cycle motor that requires oil to be mixed with the gasoline. Refer to inside front cover for **Recommended Lubricant**.

Note Recommended oil and gasoline must be properly mixed or serious engine damage will result.

FUEL/OIL RATIO

New Engine _____

The first 12 gallons (two tanks) of fuel mixture must have a fuel/oil ratio of **25:1 (4% oil)**. Refer to Starting Section, **BREAK-IN**.

Normal Operation _____

After break-in, the engine must be operated at a **50:1 (2% oil)** fuel/oil ratio.

High Performance _____

High performance operation requires a **25:1 (4% oil)** fuel/oil ratio.



1021

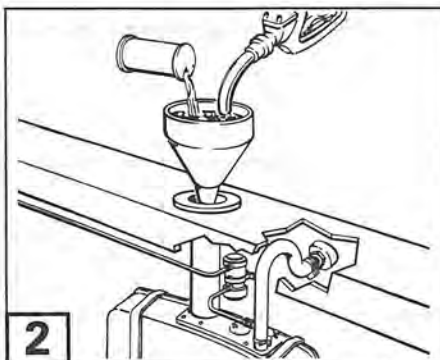

CO2335



FUEL MIXING

⚠ Safety Warning: Gasoline is extremely flammable and highly explosive under certain conditions.

- Always mix fuel outdoors, never indoors.
- Never smoke or allow open flame or sparks nearby when mixing or refueling.
- Always stop motor before refueling.
- Remove portable fuel tanks from boat when refueling.
- Prevent electrostatic spark by maintaining contact between fuel nozzle and fuel tank or metal funnel while refueling. Do not use a plastic funnel.

Lubricant Required

Ratio	6 U.S. Gallons Fuel	1 Litre Fuel
100:1	8 Fl. Oz.	10 ml.
50:1	16 Fl. Oz.	20 ml.
25:1	32 Fl. Oz.	40 ml.

Above 32° F. (0° C.) _____

1 Portable Tank - Pour oil into tank, add gasoline. Replace filler cap and thoroughly mix by shaking tank.

2 Permanently Installed Tank - Pour oil slowly with the gasoline as tank is filled.

Below 32° F. (0° C.) _____

1 Portable Tank - Pour about 1 gallon (4 litres) of gasoline into tank. Add all required oil. Replace filler cap and thoroughly mix by shaking tank. Add balance of gasoline.

2 Permanently Installed Tank - In a separate container, mix all oil needed with 1 gallon (4 litres) or more of gasoline. Pour this mixture slowly with gasoline as tank is filled.

FUEL SYSTEMS

Portable _____

OMC portable fuel tanks and fuel line assemblies are designed to provide correct fuel flow for your engine requirements.

Built-In _____

The fuel distribution lines must deliver the correct fuel flow rate for the engine. The minimum inside diameter for fuel lines is:

- V4 Models and smaller - 5/16" (8 mm)
- V6 Models - 3/8" (9 mm)

Note Fuel systems with built-in tanks, particularly those that include anti-siphon valves and filter/primer units, may have restrictions that will not allow the engine fuel pump to deliver the proper amount of fuel under all conditions. This can result in a loss of performance and possible engine damage. If a performance problem exists, see your DEALER.

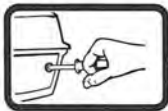

Break-In	10
Starting	11
Stopping Engine	12
Shifting and Speed Control	13
Emergency Starting	13

BREAK-IN

To protect your new outboard motor during the initial hours of operation and to seat internal engine components, you must add extra oil during the break-in period.

The fuel/oil ratio for the first 12 gallons (two tanks) must be **25:1 (4% oil)**.

Note During the break-in procedure, the engine requires a fuel/oil ratio of **25:1**. During normal operation, the fuel/oil ratio for your engine must be **50:1**.

- Note**
- DO NOT operate motor out of water. Water pump can be damaged or engine can overheat.
 - DO NOT operate engine at a constant throttle setting. Change engine RPM often.

First 20 Minutes _____

Operate engine in gear at fast idle speed **only**. DO NOT exceed 1500 RPM.

Note Verify water pump operation by looking for a steady stream of water at the water pump indicator.

Next 40 Minutes _____

Operate engine below 1/2 throttle. DO NOT exceed 3500 RPM.

Note With easy planing boats, use full throttle to bring boat onto plane then immediately reduce engine speed to 1/2 throttle.

Next Nine Hours _____

Bring boat onto plane and operate engine below 3/4 throttle. DO NOT exceed 4500 RPM.

Every 30 minutes, operate engine at full throttle for approximately one minute.

Note DO NOT exceed recommended maximum engine RPM. Refer to Maintenance Section, **SPECIFICATIONS**.

Note After the first 20 hours of operation, return your motor to your DEALER for inspection and adjustment. Refer to the Maintenance Section, **20 HOUR CHECK**.

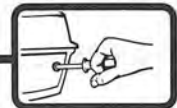
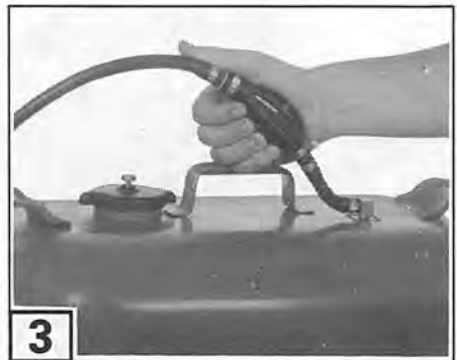
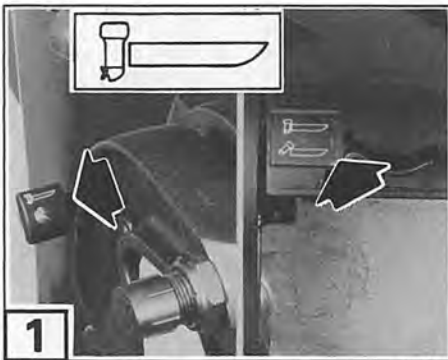

STARTING

Note • Failure to follow the **BREAK-IN** procedure can result in serious engine damage.

- Do not operate motor out of water. Water pump can be damaged or engine can overheat.

1 Move tilt/run lever or tilt/run tab to RUN position and place motor in normal (vertical) position.

! **Safety Warning:** Motor does not have impact protection or reverse lock when the tilt/run lever is the TILT position. Motor could tilt into boat suddenly, causing loss of control or serious injury.

2 Snap fuel line connector onto engine connector.

3 If equipped, open vent screw on fuel tank filler cap.

3 Squeeze primer bulb, outlet end up, until resistance is felt.

4 Attach clip and lanyard assembly to the emergency stop switch. Attach lanyard to secure place on clothing.

5 Turn throttle grip to SHIFT position or slower, move shift lever to NEUTRAL position. Refer to **SHIFTING and SPEED CONTROL**.

6 Turn throttle grip to START position.

! **Safety Warning:** Always shift to NEUTRAL before starting engine to avoid sudden boat movement and a possible man overboard situation.

Note To avoid engine damage:

- DO NOT run engine above 2500 RPM in NEUTRAL.
- DO NOT run engine above 1500 RPM in NEUTRAL for extended periods of time.

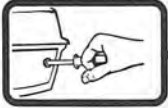
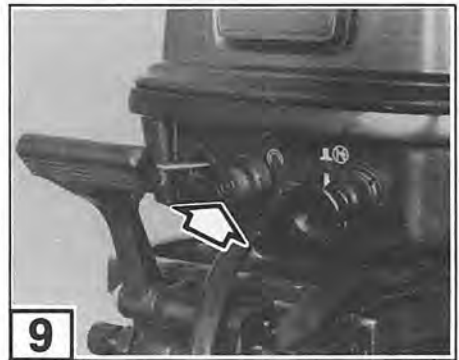

Cold Engine _____

7 Starting a cold engine normally requires use of the engine primer. Pull primer knob through its full stroke twice and return to the warm-up (color line showing) position.

The manual primer has two functions. It primes the engine for quick cold starting and provides extra fuel for warm-up.

Rope Start

8 While seated, grasp starter handle and pull slowly until starter engages, then pull hard. Allow starter cord to rewind before releasing handle to prevent damage to starter assembly. If motor does not start after a few rope pulls, prime again.

Repeat as needed until engine starts.

Electric Start

9 While seated, press start button to START motor.

Release start button as soon as engine starts. If engine does not start, release button momentarily and then try again.

- Note**
- Starter motor can be damaged if operated continuously for more than 10 seconds.
 - DO NOT press start button to START position when engine is running. Starter and flywheel will be damaged.

Repeat as needed until engine starts.

All Models

Push primer in to RUN position (no color line showing) when motor is sufficiently warmed up.

If engine does not start, refer to Maintenance Section, **TROUBLE CHECK CHART**.

After Engine Starts _____

10 Check the water pump indicator. A steady stream of water indicates that the water pump is working.

Note If a steady stream of water is **not visible**, stop engine and refer to the Operation Section, **OVERHEATING**.

Warm Engine _____

Follow **Cold Engine** procedure **except** warm engine does not normally require priming. If engine fails to start, then prime.

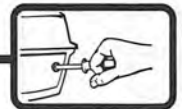
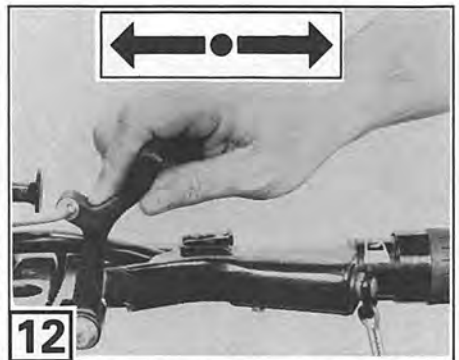
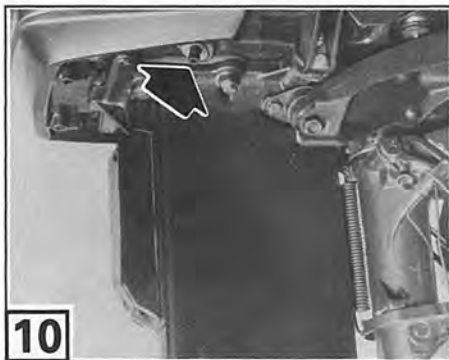

STOPPING ENGINE

Twist throttle grip toward SHIFT or slower.

Shift to NEUTRAL.

11 Press stop button until engine stops. DO NOT stop motor by shutting off fuel.

If equipped, close vent screw on fuel tank filler cap.

SHIFTING and SPEED CONTROL

Shifting

Note DO NOT shift motor into FORWARD or REVERSE when engine is NOT running.

Twist throttle grip toward SHIFT or slower.

12 Move shift lever briskly in desired direction to the shift detent position.

Note When shifting, always reduce throttle to SHIFT or slower and pause until motor is at idle speed and boat has slowed.

Speed Control

Turn throttle grip toward FAST (counterclockwise) or SLOW (clockwise) position as desired.

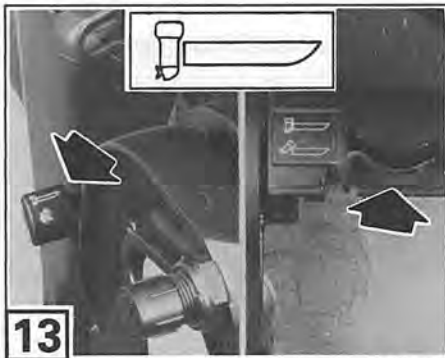

DR3473



20900

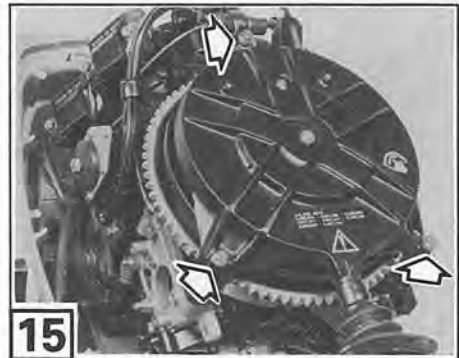

5375

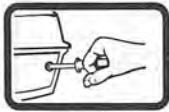

EMERGENCY STARTING

If the starter cord breaks or the starter fails, your engine can be started using a piece of the starter cord or a ¼ in. (6 mm) cord about 4 ft. (1,2 m) long.

Safety Warnings:

-  • When using Emergency Starting procedures, the “start-in-neutral only” feature is inoperative. Make sure shift lever is in NEUTRAL position to prevent sudden boat movement when engine starts.
- The engine cover is a machinery guard. To prevent injury, keep hands, clothing, and hair clear of all moving parts. DO NOT turn flywheel by hand. Use starter cord only.
- Do not touch ignition coils or spark plug leads when motor is being started or running. Shock can cause serious personal injury under certain conditions.

Electric Start Models

- Do not use jumper cables and a booster battery to start engine. Do not charge a battery in the boat with an external charger. Fumes vented during either operation can lead to an explosion.

- 13** Place motor in the RUN  position.

Move shift lever to NEUTRAL.

- 14** Pull latch down and remove engine cover.

Manual Start Models

- 15** Remove 3 screws that secure the manual starter. Lift manual starter off engine.

- 16** Use a screwdriver and apply pressure to one side of starter cable locking tabs, as illustrated. While applying pressure, pull cable until tab is clear of starter housing. Repeat procedure for remaining locking tab and remove cable from starter housing. Place starter lockout cable in lower engine cover.

Note To prevent damage to starter lockout cable, secure cable in lower engine cover in a position that does not interfere with or engage moving parts.

- 17** Tie a knot in one end of your emergency starter cord. Hook knot in notch on flywheel and wind cord clockwise around starter ridge on flywheel.

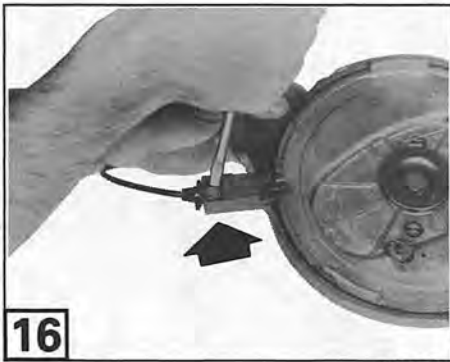

COA2289

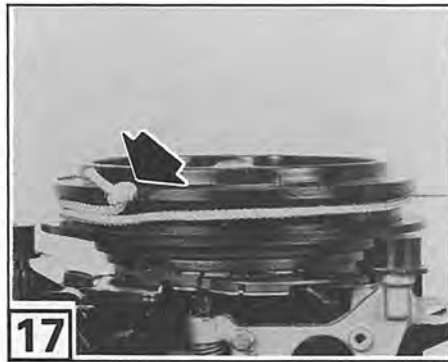

24676

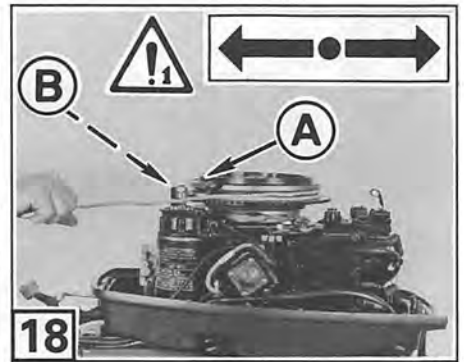

20909



Electric Start Models _____

18 Using emergency starting cord provided, place the cord knot **A** in notch on flywheel pulley. Wrap cord around pulley clockwise, making sure knot will clear starter pinion **B**.

All Models _____

If using the portable six-gallon fuel tank, slowly remove filler cap to relieve the pressure in the tank. Close cap.

⚠ Safety Warning: During above step, gasoline vapors and possibly liquid fuel will be released. Gasoline is extremely flammable and highly explosive under certain conditions. Do not smoke or allow open flames or spark near the boat when the filler cap is removed from the fuel tank.

Follow starting procedure. Refer to **STARTING**.

Pull hard on emergency starting cord to start motor.

After starting, run engine at less than 2500 RPM in NEUTRAL for 2 minutes. Then reduce speed to an idle.

Do not attempt to replace manual starter or engine cover while engine is running. Attach lanyard to secure place on clothing.

Proceed to nearest boat landing for service.

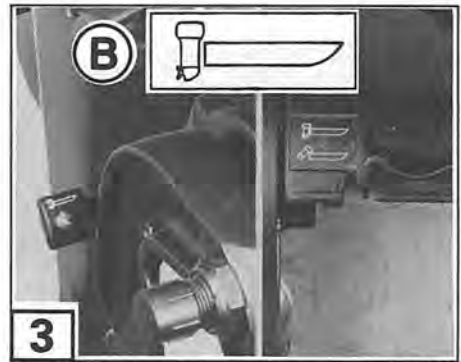
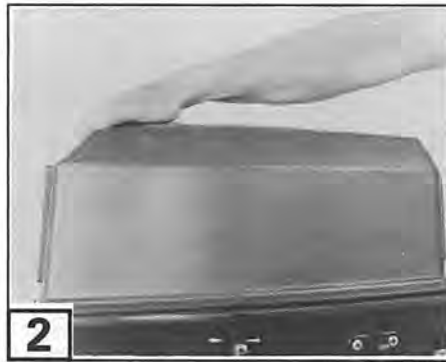
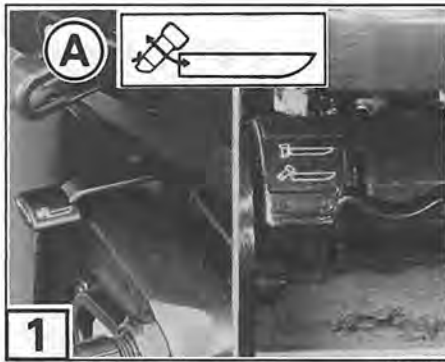

Propeller Selection	16	Trailing	18
Tilting	16	Storage	18
Shallow Water Drive	17	Motor Angle Adjustment	19
Overheating	18	Special Operating Conditions	19
Impact Damage	18		

PROPELLER SELECTION

To select the correct propeller for your boating application, your boat and motor **MUST** be water tested. See your DEALER for assistance.

Refer to Maintenance Section, **PROPELLER**, before removing or installing propeller.

Note The correct propeller for your boat, under normal load conditions, will allow the engine to run near the midpoint of the RPM operating range at full throttle. Refer to Maintenance Section, **SPECIFICATIONS**.

TILTING

Note Do not push down on tiller handle to raise motor.

Program Tilt Models

Tilt Motor _____

- 1 Move tilt/run lever to the TILT position (A).
- 2 Grasp tilt grip on engine cover and raise motor to the full tilt position.

- Tilt support will automatically engage.

⚠ Safety Warning: While engine is tilted, leave tilt lever in the TILT position. If lever is in the RUN position, the tilt support can release unexpectedly and allow motor to drop.

Lower Motor _____

- 3 Move lever to the RUN position (B).
- 2 Grasp tilt grip on engine cover and raise motor slightly to disengage support. Lower motor into normal (vertical) position.

Tilt Lock Models

Tilt Motor _____

- 1 Move tilt/run tab to the TILT position (A).
- 2 Grasp tilt grip on engine cover and raise motor to the full tilt position.
- 4 Flip tilt support handle (C) down to engage.

Gently lower motor onto support.

Lower Motor _____

- 4 Flip tilt support handle (C) up to disengage.
- 2 Grasp tilt grip on engine cover and raise motor to the full tilt position.

Lower motor into normal (vertical) position.

- 1 Move tilt/run tab to the RUN position (B).

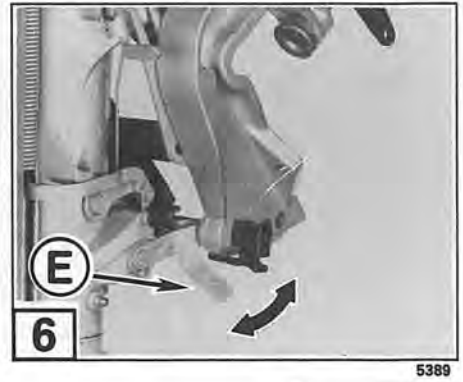
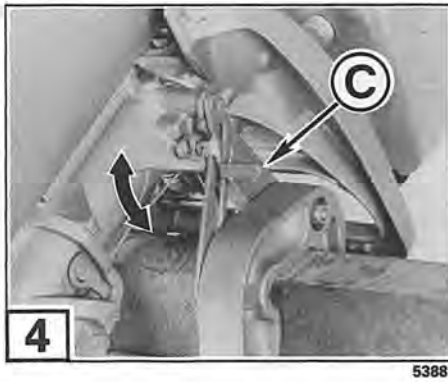

SHALLOW-WATER DRIVE

The motor's position in shallow-water drive is controlled by the position of the motor angle adjusting rod. Refer to **MOTOR ANGLE ADJUSTMENT**. Slow engine and shift to NEUTRAL before engaging or disengaging shallow-water drive.

⚠ Safety Warning: Operate at slow speeds only. The motor does not have impact protection when operated in the shallow-water drive position. Motor will tilt up suddenly if it hits an obstruction.

Program Tilt Models - Engage

- 1 Move tilt/run lever to TILT  position (A).
- 2 Grasp tilt grip on engine cover and raise motor halfway.
- 5 Shallow-water drive bracket (E) will automatically engage.

Slowly lower motor until shallow-water drive bracket rests against motor angle adjusting rod.

Disengage

- 3 Move lever to the RUN  position (B).
- 2 Grasp tilt grip on engine cover and raise motor slightly. Shallow water drive bracket will automatically disengage.

Lower motor to the normal (vertical) position.

Tilt Lock Models - Engage

- 1 Move tilt/run tab to TILT  position (A).
- 2 Grasp tilt grip on engine cover and raise motor halfway.
- 6 Flip down shallow-water drive bracket (E).

Slowly lower motor until shallow-water drive bracket rests against motor angle adjusting rod.

Disengage

- 3 Move tilt/run tab to RUN  position (B).
- 2 Grasp tilt grip on engine cover and raise motor slightly.
- 6 Flip up shallow-water drive bracket (E).

Slowly lower motor into normal (vertical) position.

SHALLOW WATER OPERATION

Note DO NOT operate motor with gearcase dragging on bottom. This can result in propeller or water pump damage.

Place motor in shallow water drive position. Refer to **SHALLOW-WATER DRIVE**.

⚠ Safety Warning: DO NOT operate motor in REVERSE with the tilt/run lever in the TILT  position. Motor can tilt up suddenly resulting in loss of control.

Run at SLOW SPEED ONLY. Check the water pump indicator often.

Before operating in deeper water, be sure to lower motor and move tilt/run lever to the RUN  position.

⚠ Safety Warning: Motor does not have impact protection when operated in the shallow water drive position or when the tilt/run lever is in the TILT  position. Motor will tilt up suddenly if it hits an obstruction.

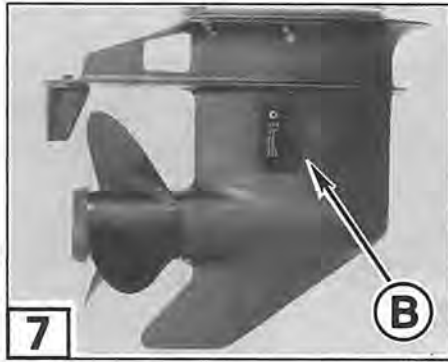

24754

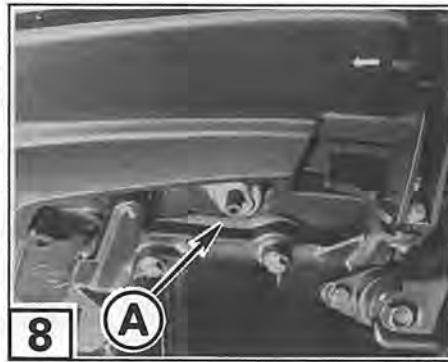

18521



ENGINE OVERHEATING

8 When engine is running, the water pump indicator **A** must be discharging a steady stream of water. Check the indicator often, particularly when operating in weeds, mud, debris laden water, or at an extreme trim angle.

If the engine overheats, the S.L.O.W.[™] overheat warning system will automatically limit engine speed to approximately 2000 RPM.

IF the water pump indicator stops or becomes intermittent, reduce engine speed to an idle and:

- Shift motor into REVERSE and operate at a slow speed for about 10 seconds, then shift back into NEUTRAL. This could clear debris blocking the water intake screens.

IF the indicator is still **not discharging** a steady stream of water, STOP  the motor and:

7 8 • Clean the intake screens **B** and the water pump indicator **A**. Restart engine and run at idle.

IF the water pump indicator still **does not discharge** a steady stream of water, STOP  the motor. DO NOT attempt to operate motor. See your DEALER for service.

IF a steady stream of water is **visible** from the water indicator:

- Continue to run engine at IDLE only. Idle the engine until it returns to normal operating temperature.

Important After the engine has cooled, it must be operated at idle speed to reset the S.L.O.W.[™] overheat warning system. The engine can now be operated above 2000 RPM.

Note After overheating, have your DEALER torque the cylinder head and exhaust cover screws and DETERMINE THE CAUSE OF THE OVERHEAT.

IMPACT DAMAGE

Your boat and motor can be seriously damaged by a collision at high or low speeds, while trailering, or while in the water.

If you hit any object, stop immediately and examine the motor for loosening of attaching hardware or clamp screws, if equipped. Inspect for damage to swivel and stern brackets, steering components, and components in the area of impact. Also, examine the boat for structural damage. Tighten any loosened hardware. If collision occurred in the water, proceed slowly to shore. Before boating again, have your DEALER thoroughly inspect all components.

⚠ Safety Warning: Failure to inspect for damage could result in sudden, unexpected component failure and loss of boat control. Unrepaired damage could reduce your boat and motor's ability to resist future impacts.

TRAILERING

The motor should be trailered in the normal (vertical) position. Additional road clearance can be obtained by placing the motor angle adjusting rod in an outer stern bracket position, refer to **MOTOR ANGLE ADJUSTMENT**. If trailer construction still does not provide adequate road clearance, see your **DEALER** for an accessory trailering bracket.

Note DO NOT use the tilt support as a trail lock.

STORAGE

The motor should be stored in the normal (vertical) position. If it is necessary to store the motor tilted, the tilt/run lever must be left in the TILT  position at all times. Refer to Maintenance Section, **OFF-SEASON STORAGE**.

Note When removing motor from water, allow cooling system to drain completely by placing the motor in the normal (vertical) position.

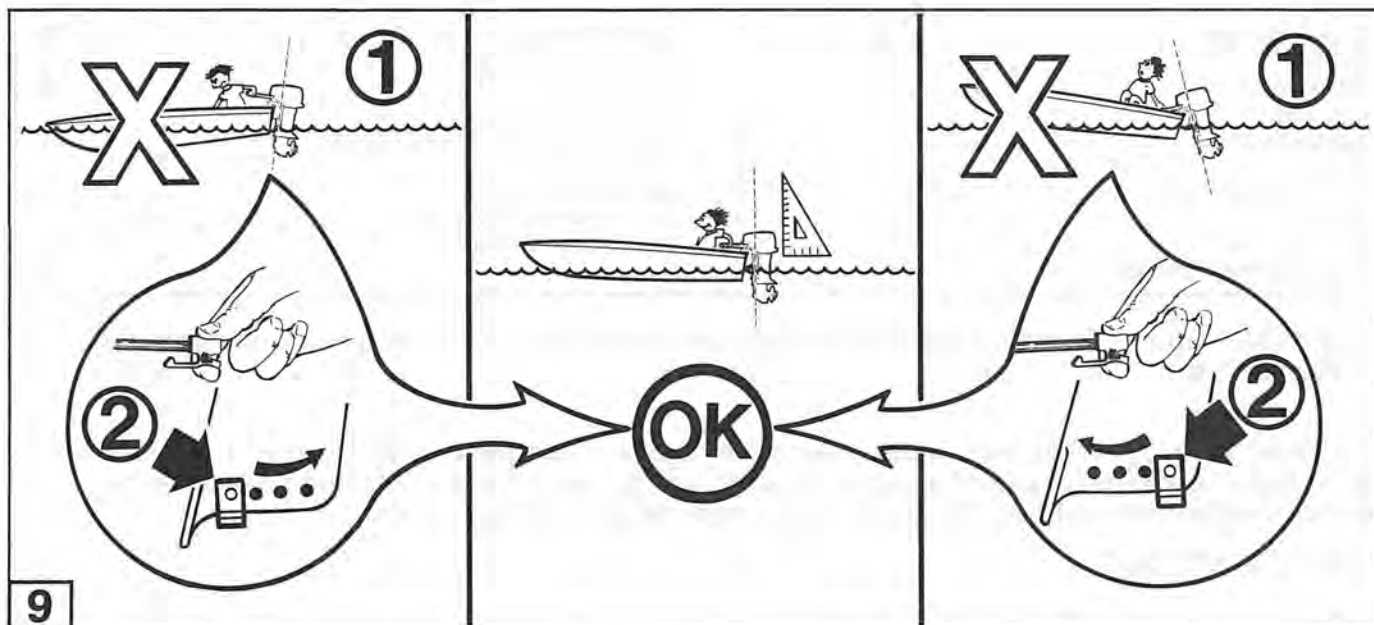

DR3279

MOTOR ANGLE ADJUSTMENT

Motor should be perpendicular to the water when the boat is underway at full speed. This adjustment can only be determined by water testing the boat. Set angle adjustment for your normal load.

Place motor in full tilt position. Refer to **TILTING**.

9 Move angle adjusting rod as shown.

SPECIAL OPERATING CONDITIONS

Salt Water

Fresh water internal flushing is recommended after use in salt, polluted, or brackish water to prevent deposits from clogging the cooling passages. See your DEALER for the appropriate flushing device.

Note During use in salt or brackish water additional anodic protection for the boat and motor may be required.

During long periods of non-use, tilt motor so that the gearcase is out of the salt water, unless the temperature is below 32° F (0° C). When removing motor from salt water, allow cooling system to drain completely by placing motor in normal (vertical) position.

Weedy Water

Weeds can block the water intakes and cause engine to overheat. Weeds on the propeller will cause motor to vibrate.

Run at slow speeds and reverse motor frequently to clear weeds from propeller. Check water pump indicator often. Remove weeds from propeller and water intakes before operating in clear water.

Freezing Weather

To avoid motor damage, keep the gearcase submerged in the water at all times. Before operating in freezing temperatures, check gearcase lubricant. If leakage is found, gearcase seals will need service. See your DEALER.

When removing motor from water, keep motor in normal (vertical) position until the cooling system is completely drained.

Note Water that leaks into gearcase or is left in the cooling system can freeze when motor is removed from water. This can cause serious damage.

High Altitude

A change of carburetor calibration or a reduction in propeller pitch might be required if your motor is operated above 3000 ft. (900 m). See your DEALER.

Note To avoid permanent powerhead damage, be sure that an engine modified for high altitude operation is properly identified and returned to original calibration if operated below 3000 ft. (900 m).

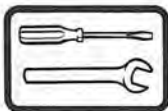

Specifications	20	Boat's Bottom	28
Battery	21	Submerged Motor	28
Adjustments	22	Trouble Check Chart	29
Lubrication	24	AC Lighting	30
Spark Plugs	26	Owner's Service Responsibility	31
Anti-Corrosion Anodes	26	20-Hour Check	31
Fuel Pump Filter	26	Warranty Service	31
Propeller	27	Off-Season Storage	32
Fish Line Trap	27	Pre-Season Service	33
Maintenance Schedule	28		

⚠ Safety Warning: To avoid accidental starting of engine while servicing, twist and remove all spark plug leads.

⚠ Safety Warning: When replacement parts are required, use genuine OMC parts or parts with equivalent characteristics including type, strength and material. Failure to do so may result in product malfunction and possible injury to the operator and/or passengers.

SPECIFICATIONS

	Specifications	Page
Power*	20 hp (14,9 kw) @ 5000 RPM - 20 25 hp (18,2 kw) @ 5000 RPM - 25 IR 25 hp (18,7 kw) @ 5000 RPM - 25 RA, RE, RL, TE 30 hp (22,4 kw) @ 5500 RPM - 30 35 hp (26,1 kw) @ 5500 RPM - 35	•
Full Throttle Operating Range	4500 to 5500 RPM - 20, 25 5200 to 5800 RPM - 30, 35	2
Fuel Requirements	67 AKI, (69 RON) - See 	8
Fuel/Oil Ratio	50:1	8
Fuel Capacity	6 U.S. Gallons (22,7 litres)	•
★Battery, Minimum	350 CCA @ 0°F (-18°) 100 Minute Reserve @ 80°F (27°C)	21
Alternator	4 Amps, Nonregulated - Electric Start Models	•
AC Lighting	60 Watts AC @ 12 Volts - 20BF, 25RA, 25IR, 30BA	28
Spark Plug (2) <i>Champion:</i> Alternate Torque	QL77JC4 @ 0.030" (0,76 mm) Gap L77JC4 @ 0.030" (0,76 mm) Gap 17-20 ft. lbs. (24-28 N·m)	24
Gearcase - Lubricant - Capacity	<i>OMC Hi-Vis®</i> Gearcase Lube 12.2 fl. oz. (361 ml)	22
Propeller	10 X 13 in. (25 X 33 cm) - 20, 25 10 X 15 in. (25 X 38 cm) - 30, 35	25
Transom Height	14½ to 15 in. (368 to 381 mm) - AE, EE, FE, RE 19½ to 20 in. (495 to 508 mm) - AL, EL, FL, RL	32
Weight	116 lbs. (53 kg) - AE, FE, RE 118 lbs. (54 kg) - AL, FL, RL 122 lbs. (55 kg) - EE 124 lbs. (56 kg) - EL	•

*Rated at the propeller shaft, according to NMMA procedures.

★DO NOT use maintenance-free or sealed batteries.

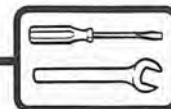

BATTERY

The battery and battery box are not supplied with the motor. Read and understand battery manufacturers safety information supplied with the battery before installation is attempted. Install battery in a vented battery box that is securely mounted in the boat. Refer to **SPECIFICATIONS** for minimum battery requirements.

Note Maintenance free or sealed batteries are acceptable for use **ONLY** on engines that are equipped with a fully regulated alternator. Refer to **SPECIFICATIONS**.

Battery Replacement

! Safety Warning: Failure to ensure clean, tight electrical connections might result in sparks that can ignite fuel vapors under the engine cover.

This motor has a negative ground.

Important The BLACK battery cable must be connected to the negative (-) terminal on the battery. The BLACK with RED STRIPE battery cable must be connected to the positive (+) terminal on the battery.

Note If the battery cables are reversed, the charging unit will be damaged. DO NOT attempt to connect or disconnect any part of the electrical circuit while the motor is running.

Make sure that cable clamps are tight to ensure a good connection. Apply *OMC Triple-Guard®* grease to the exposed areas of the battery posts and cable clamps to reduce corrosion.

Make regular checks to ensure clean tight connections throughout the electrical system.

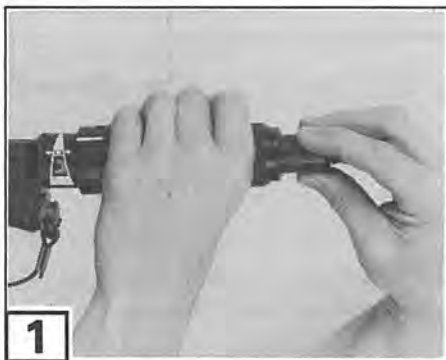

24333

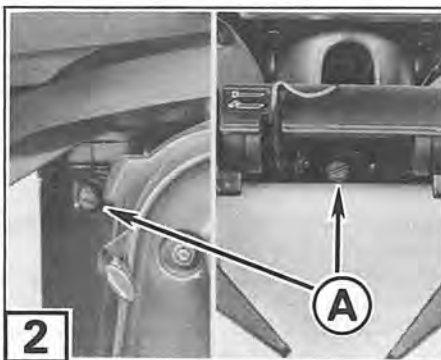

DR3479

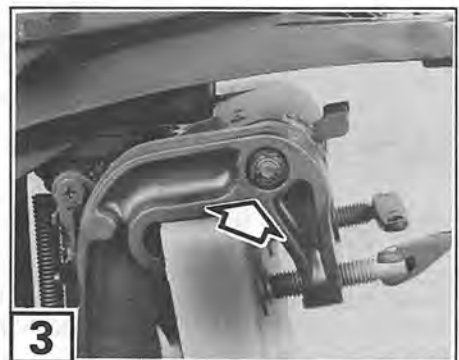

24663

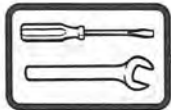

ADJUSTMENTS

Idle Speed Adjustment

1 The idle speed adjustment knob is located on the steering handle. Turning clockwise on the knob increases idle speed, turning counterclockwise decreases idle speed. Make certain that throttle grip is in slow position and the motor is a normal operating temperature before making the idle speed adjustment.

Steering Friction

2 The steering friction was set on your new motor before it left the factory. After the first 20 hours of service, check to see that it is still correct; a slight drag should be felt when turning the motor. If adjustment is necessary, turn the adjustment screw A clockwise to increase friction or counterclockwise to reduce friction.

⚠ Safety Warning: DO NOT overtighten for "hands-off" steering. Reduced steering control could result.

Tilt Friction - 20/25 Models

3 The tilt friction nut should be adjusted ONLY enough to control return of gearcase from tilt to normal (vertical) position.

Carburetor

High speed fuel calibration is maintained by the fixed high speed jet in the carburetor. Fixed jets are not adjustable.

Low speed fuel calibration is set at the factory with a range of adjustment provided. If your engine displays poor running quality at low speed or idle, ask your DEALER to perform the necessary adjustments.

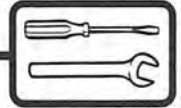
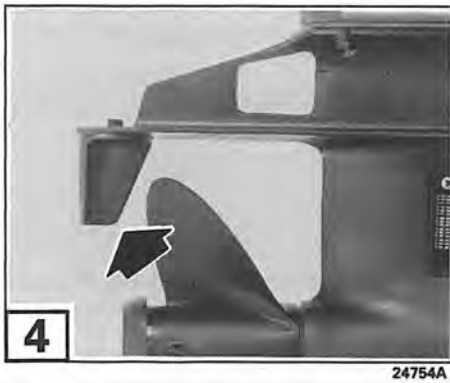

Trim Tab

⚠ Safety Warning: Improper trim tab adjustment can cause difficult steering.

4 An adjustable trim tab allows steering effort to be balanced when turning in either direction.

To adjust:

- Select a calm windless area.
- Distribute weight evenly in boat.
- With a firm grip on the steering handle, run the boat at full throttle in a straight line.
- Turn the steering handle to determine the direction that requires the least amount of steering effort.

- Stop boat. Loosen trim tab screw.
- If less steering effort is required in a port turn, move trim tab slightly to port.
- If less steering effort is required in a starboard turn, move the trim tab slightly to starboard.
- Retighten trim tab screw.
- Repeat the procedure until the steering effort is equal in both directions.
- Torque screw to 60-85 in. lbs. (7-9 N·m).

For twin engine installations, follow the same procedure **except** both trim tabs should adjusted the same amount.

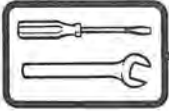

LUBRICATION

Frequency

- At least every 30 days - salt or polluted water
- At least every 60 days - fresh water
- Before a period of storage
- More often, as experience indicates

Note The recommended OMC lubricants have been formulated to protect bearings and gears. They must be used to avoid damage caused by improper lubrication.

Figure	Lubrication Point	Lubricant
1	*Gearcase	B
2	Throttle and Shaft Linkage, Rear Engine Cover Latch, Starter Neutral Lockout (Manual Start)	A
3	Tilt Pin, Clamp Screws, Tilt Lever Shaft (30/35)	A
4	Shift Lever Shaft	A
5	Carburetor, Cam and Shifter Starter Lockout (Electric Start)	A
6	Electric Starter	C
7	Swivel Bracket, Tilt Support, Shallow Water Drive Bracket	A

*Recommended Dealer Performed Service.

Gearcase

1 Replace gearcase lubricant after first 20 hours of operation. Check level and condition of lubricant after next 30 hours of operation. Add lubricant if necessary.

Thereafter, check level and condition of lubricant every 50 hours. Replace lubricant every 100 hours of operation or once each season, whichever occurs first. Refill with *OMC Hi-Vis®* gearcase lubricant. If not available, use *OMC Premium Blend®* gearcase lubricant. See your DEALER.

With motor in normal operating position:

1. Remove drain/fill plug ① and lubricant level plug ② from side of gearcase and completely drain gearcase of old lubricant.

2. Examine drained lubricant for metal filings, milky appearance, or black color with burnt odor. If old lubricant has any of those characteristics, see your DEALER. If drained lubricant is in good condition, continue.

3. Place tube of lubricant in drain/fill hole and fill until lubricant appears at lubricant level hole. See **SPECIFICATIONS** for gearcase capacity.

4. Install lubricant level plug ② before removing tube from drain/fill hole. Drain/fill plug ① can then be installed without loss of lubricant.

5. Securely tighten both plugs.

Important Do not remove shift cradle screw ③.

OMC Triple-Guard [®] Grease	OMC Hi-Vis [®] Gearcase Lube	General Electric Versilube
<p>Tube</p>		

DR3294

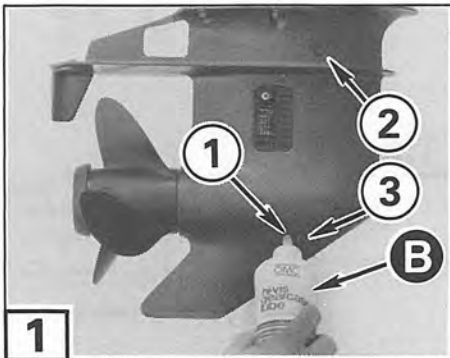
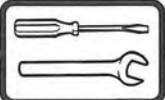

24768

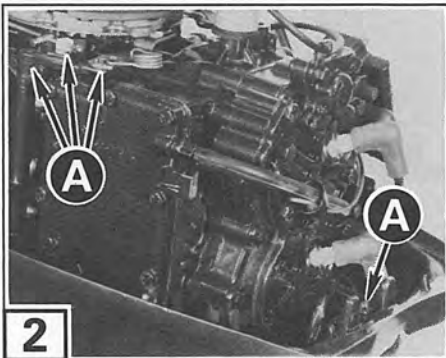

17004

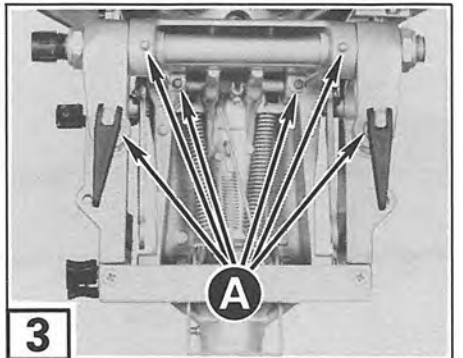

14425

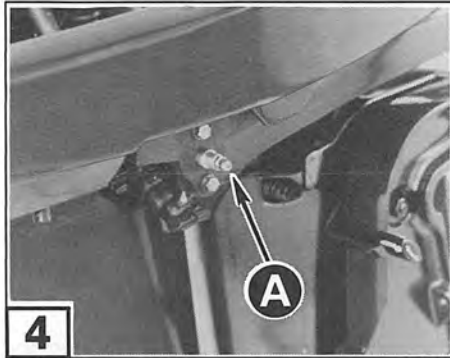

21243

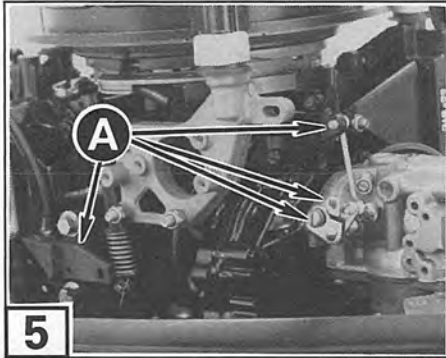

21248

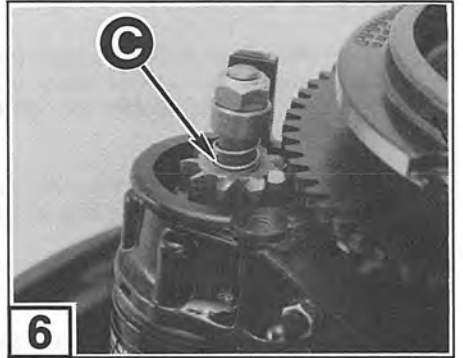

21241

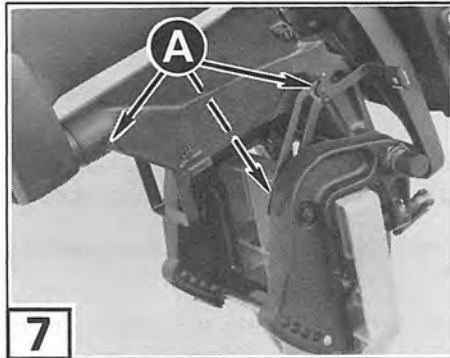

24771

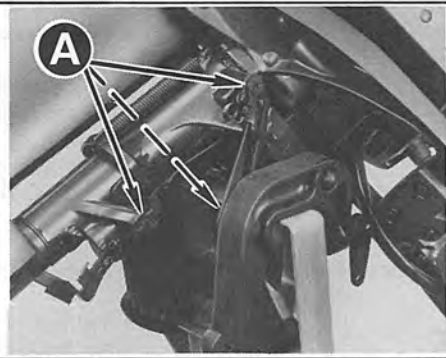

24660

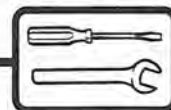
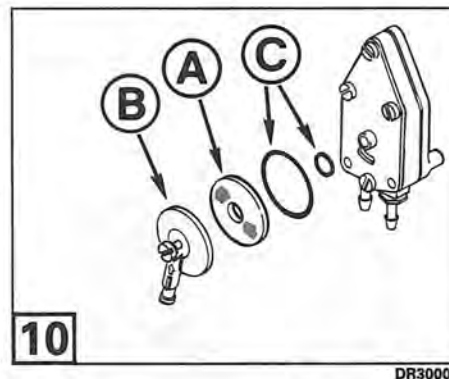
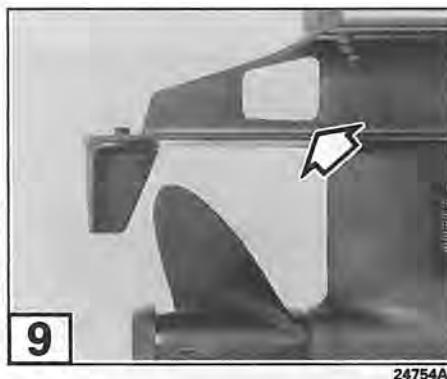
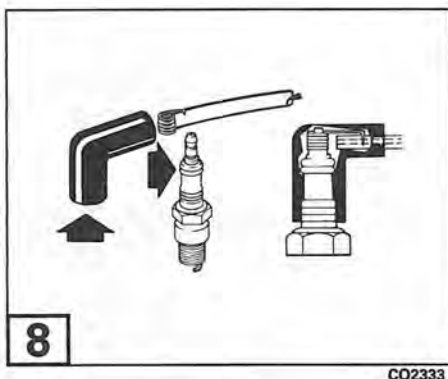

SPARK PLUGS

⚠ Safety Warning: Avoid abusive handling which could crack ceramic portion of spark plug. Damaged spark plugs can emit sparks; sparks can ignite fuel vapors under the engine cover.

Inspect spark plugs periodically. Replace if electrodes are badly worn, insulators are cracked, or they are badly fouled.

To remove spark plugs, twist and remove all spark plug leads. Unscrew spark plugs and remove from cylinder head.

To install spark plugs, first wipe spark plug seats clean with a clean rag. Install spark plugs finger tight, then tighten to specified torque. Refer to **SPECIFICATIONS**.

Note Avoid engine damage:

- Do not install spark plugs into a warm cylinder head
- Do not overtighten

8 Before installing the spark plug lead, apply a light coat of *OMC Triple-Guard®* grease to the ribbed portion of the spark plug insulator and the opening of the spark plug cover. This will help prevent corrosion between the spring terminal and the spark plug.

ANTI-CORROSION ANODES

Your motor is equipped with one or more anti-corrosion anodes to protect the motor from galvanic corrosion. Galvanic corrosion can occur in fresh or salt water, however, salt and polluted waters will accelerate corrosion.

9 Disintegration of anode is normal and indicates it is working. Periodically check the condition of each anode and replace if less than 2/3 original size. See your DEALER for replacement anodes.

Note NEVER paint the anode, its fasteners, or its mounting surface. If you do, corrosion protection from the anode will be reduced.

Do not use copper or graphite based paint on boat bottom because those compounds can increase galvanic corrosion. Anti-fouling paint containing TBTA or TBTF is acceptable where its use is permitted by environmental regulations.

FUEL PUMP FILTER

Note The fuel pump filter should be inspected and cleaned after every 100 hours of operation, or once a season, whichever comes first.

⚠ Safety Warning: To prevent excessive fuel spillage, disconnect fuel line connector at motor before disassembly.

10 The filter **A** is located under the inlet cover **B** on the fuel pump. To service, proceed as follows:

- Loosen screw and remove the cover **B**. Do not lose O-rings **C**.
- Wash filter element with clean solvent and blow dry.
- Reinstall filter keeping lip of filter screen toward fuel pump body.
- Install large O-ring in its groove in the cover and the small O-ring around center post of pump body.
- Reinstall cover, positioning inlet nipple between screw heads.
- Tighten cover screw securely and clean up any spilled fuel.
- **Check for leaks** by connecting fuel line to motor and squeezing primer bulb until definite resistance is felt in bulb.

⚠ Safety Warning: Failure to inspect your work could allow fuel leakage to go undetected. This could become a fire or explosion hazard.

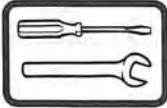
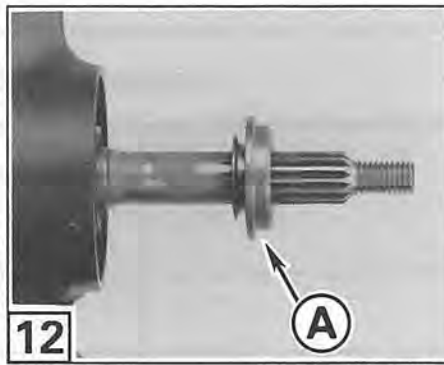
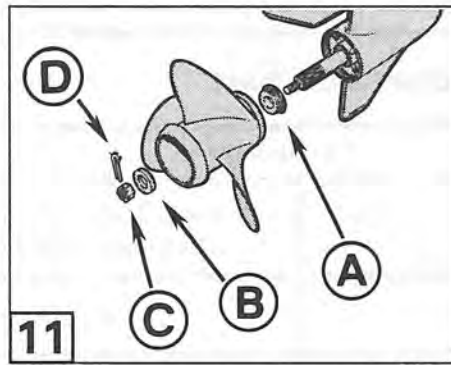

PROPELLER

⚠ Safety Warning: To avoid accidental starting of engine while changing propellers, twist and remove all spark plug leads.

Installation

11 12 Apply *OMC Triple-Guard®* grease to entire propeller shaft.

- Thrust bushing **A** - Fish line trap groove must face forward.
- Propeller - Be sure it seats on thrust bushing.
- Spacer **B** - Engage propeller shaft splines.
- Propeller nut **C** - Tighten securely.
- Cotter pin **D** - Install new pin through propeller nut and shaft. **DO NOT** loosen propeller nut to align holes. Spread ends of cotter pin to secure the assembly.

Make sure engine is in NEUTRAL; give propeller a spin. It must turn freely.

Repair

If your propeller hits a solid object, the impact is absorbed by the rubber bushing in the hub to help prevent damage to motor. A strong impact can damage rubber bushing and propeller blades. Damage to propeller blades can cause unusual and excessive vibration. Damage to rubber bushing can cause excessive engine RPM with little forward movement.

Note Avoid or limit operation using a damaged propeller. Carry a spare propeller.

Keep your propeller in good condition. Use a file to smooth slight damage to blade edges. See your DEALER for repair of serious damage.

Fish Line Trap

12 The thrust bushing **A** contains a built-up groove as a trap for fish line. Every 15 to 20 hours of operation, or whenever you suspect the presence of fish line, remove the propeller and check the trap. Remove whatever debris you find.

Note Fish line can damage propeller shaft seals. Damaged seals can allow water to enter the gearcase, causing internal damage.

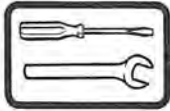

Maintenance Schedule Chart

Service Point	Frequency †			Page
	First 10 Hours	First 20 Hours	Every 100 Hours or Once every season	
Fuel Filter	*		*	26
Gearcase	●			24
Cylinder Head Screws	●			●
Carburetor	●			22
Propeller	●			27
Timing & Ignition	●			●
Lubrication Points	●	●	See Lubrication Chart	24
Spark Plugs	●		*	26
Engine Tune-Up	●	●		●
Motor Adjustment	●	*	*	22

DR2414 ENG

† Severe usage may require more frequent service. See your DEALER.

● Not applicable

* Owner performed service



Recommended DEALER performed service.

EXTERNAL FINISH

Your motor has a baked enamel finish designed for use in either fresh or salt water.

After operating in **FRESH** water, wipe motor with a dry cloth. Periodically wash entire motor with soapy water and apply a coat of automotive wax.

After operating in **SALT** water, rinse entire motor with fresh water and wipe dry. Periodically wash entire motor with soapy water and apply a coat of automotive wax.

Note Leave engine cover in place when washing motor.

BOAT'S BOTTOM

The condition of your boat's bottom affects performance. A covering of marine growth will reduce speed. For maximum performance of your boat and motor, keep the boat's running surface clean by wiping it dry after each use and washing it occasionally. You may also consider applying antifouling paint. Contact your DEALER for an antifouling paint suitable for your area. If paint is used, be sure it does not contact your motor's anti-corrosion anodes. Refer to **ANTI-CORROSION ANODES**.

SUBMERGED MOTOR

If your motor is submerged, it **must be serviced within three hours of recovery**. If service is not possible within that time, it must be resubmerged in fresh water to avoid exposure of machined surfaces to the atmosphere. See your DEALER.

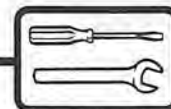

TROUBLE CHECK CHART

Symptom	Possible Cause
Starter motor will not operate	<ul style="list-style-type: none">● Shift lever not in NEUTRAL● Battery and electrical connections loose or corroded
Motor will not start	<ul style="list-style-type: none">● Emergency stop switch & lanyard not in place● Shift lever not in NEUTRAL● Fuel tank empty● Fuel line disconnected, kinked● Fuel system contaminated with water● Fuel pump filter obstructed● COLD ENGINE: Engine not primed● WARM ENGINE: Engine flooded (IF flooded: disconnect fuel line at motor, push in primer knob completely, crank engine. If it starts, run until cleared. If it fails to start, wait a few moments and try again.)● Spark plugs carboned, burned or wet● Spark plugs improperly gapped● Ignition system component failure● Review starting instructions
Motor will not idle properly	<ul style="list-style-type: none">● Carburetor mixture adjustment not set correctly● Spark plugs damaged, insulator cracked● Fuel/oil mixture incorrect
Motor loses power	<ul style="list-style-type: none">● Spark plugs damaged, insulator cracked● Fuel pump filter obstructed● Fuel system contaminated with water● Water intake obstructed and cooling system not operating correctly. Refer to Operations Section, OVERHEATING.
Motor vibrates excessively	<ul style="list-style-type: none">● Propeller blades bent, broken or missing● Propeller fouled and restricted● Carburetor mixture adjustment not set correctly● Steering friction screw loose
Motor runs, but makes little or no progress	<ul style="list-style-type: none">● Propeller hub loose, slipping● Propeller blades bent or missing● Propeller fouled and restricted

If you are unable to find or solve your problem, contact your DEALER.

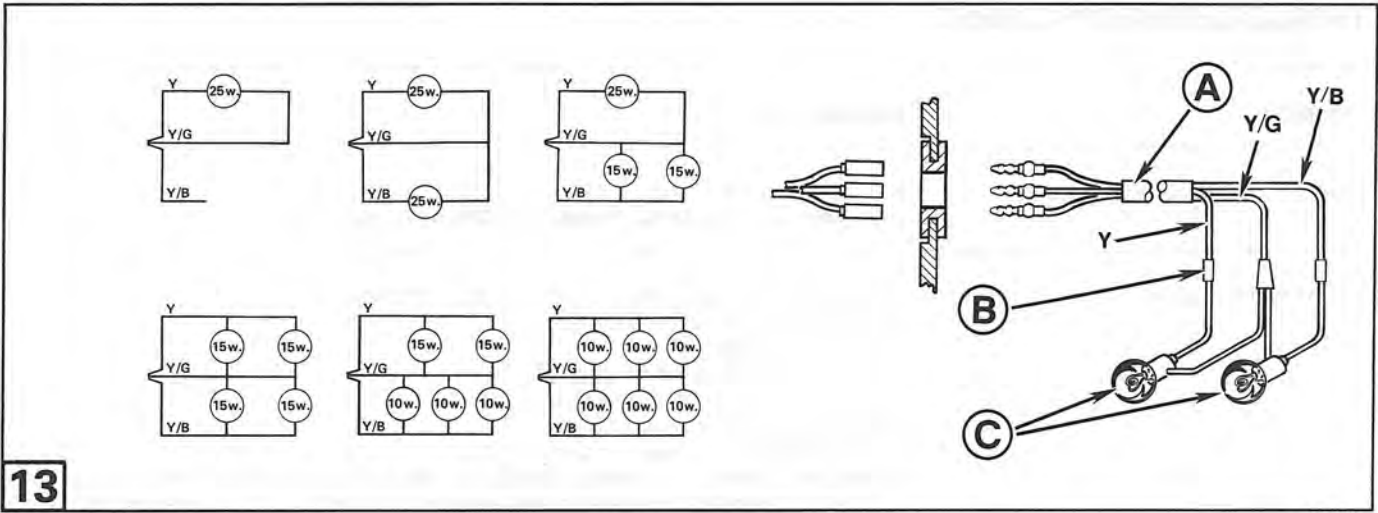
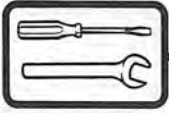

DR2923

AC LIGHTING

Some models are provided with an AC (Alternating Current) lighting system that originates at the terminal strip on the engine. This system is intended for operating lights on a boat.

Note The lighting system generates AC (Alternating Current) and must not be connected directly to a battery. DO NOT connect any electrical equipment (other than the recommended lighting) to this system.

Various combinations of light bulbs can be used. Use 12-volt light bulbs of wattage sizes indicated on the diagram.

13 Follow the illustration for proper installation of wires.

Wire Colors _____

Y - Yellow
 Y/G - Yellow/Gray
 Y/B - Yellow/Blue

Legend _____

(A) Sleeve
 (B) Cover connections with electrical tape
 (C) 25-watt bulbs

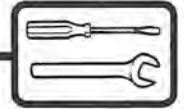

OWNER'S SERVICE RESPONSIBILITY

Service for the purpose of customary maintenance and care of your outboard motor is the responsibility of the owner and should be performed by your DEALER.

Replacement of routine service items such as spark plugs, water pump, propeller, clutch parts, and belts are not considered defects in material or workmanship within the terms of the WARRANTY.

20-HOUR CHECK

After 20 hours of operation, your new engine will be "broken in" and its mechanical parts will have "seated." At that time the break-in lube needs to be replaced and all systems should be checked. Your DEALER will do the following:

- Drain, flush and refill gearcase.
- Torque cylinder head screws and spark plugs.
- Adjust carburetor, if needed.
- Check propeller.
- Check timing and ignition system.
- Adjust remote control and linkage (where applicable).

This 20-hour check will be performed by your DEALER at your request and expense, based on local rates.

Follow a consistent preventative maintenance schedule by having your DEALER check your engine every six months or 100 hours of operation, whichever comes first.

WARRANTY SERVICE

The conditions of warranty covering your motor are outlined at the end of this manual. Read the warranty statement carefully to understand the terms and conditions that apply to you. If there is something you do not understand, contact your DEALER for more information.

If your motor needs repair during the warranty period, deliver it to an AUTHORIZED *Evinrude* or *Johnson* DEALER. The AUTHORIZED DEALER will help determine your situation under the terms of the warranty. If the repair qualifies for warranty coverage, the DEALER will submit a claim on your behalf. The DEALER will ask for your **OMC Owner's Identification Card** and will ask you to sign the claim form.

Examples of Items NOT Covered by Warranty:

- Normal service requirements arising during the warranty period such as carburetor or ignition adjustment, cleaning or repair; or wear to piston ring, cylinder, or water pump.
- Motors altered or modified so as to adversely affect their operation, performance or durability, or to change their intended use.
- Repairs made necessary by the use of parts or accessories which are either incompatible with the motor or which adversely affect its operation, performance or durability.
- Motors not operated or maintained in accordance with the instructions in the **Owner's Manual**.
- 20-hour check, tune-up, diagnosis procedures.
- Usual cleaning, adjusting, or replacing of spark plugs.
- Periodic checking or adding of lube to the gearcase.
- Expenses of transporting the motor to and from the DEALER.
- Expenses for removal of the motor from the boat and reinstallation, mechanic's travel, removal of the boat from storage or the water and return.
- Replacement of anodes.
- Off-season or preseason preparation.

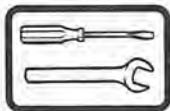

OFF-SEASON STORAGE

Your warranty does not cover engine failures caused by neglect. Temperature and humidity changes while in storage can cause corrosion of internal engine parts when they are not properly protected. Your DEALER should prepare your motor for off season storage. This is also the best time to have your DEALER perform an engine tune-up.

If you prepare your own engine for storage, proceed as follows:

Purchase *OMC 2+4*[®] fuel conditioner and *OMC Storage Fogging Oil* from your DEALER.

- Stabilize your fuel by adding *OMC 2+4* fuel conditioner to your fuel tank (1 oz. for every gallon of fuel). Operate motor in fresh water for at least five minutes to allow stabilized fuel to enter carburetor.

Note Do not operate motor out of water even momentarily. Water pump may be damaged or engine may over-heat.

- Remove engine cover.

⚠ Safety Warning: The engine cover is a machinery guard. To prevent injury,, keep hands, clothing, and hair clear of all moving parts.

- Start engine.
- Rapidly inject *OMC Storage Fogging Oil* into air silencer opening until motor smokes.
- Stop engine.

⚠ Safety Warning: To prevent accidental starting of engine while in storage, twist and remove spark plug leads.

- Remove spark plugs. Inject *OMC Storage Fogging Oil* into the spark plug holes. Slowly rotate flywheel several revolutions to distribute the lubricant and to drain water from the water pump.
- Check spark plugs. Clean or replace if necessary. Refer to **SPARK PLUGS**.
- Disconnect fuel line from motor connector and fuel tank. Coil fuel line on top of tank when not in use.

⚠ Safety Warning: To prevent accidental escape of liquid or vapors from tank which could be accidentally ignited, do the following:

- Close vent screw on filler cap if equipped.
- Disconnect fuel line from motor and tank.
- Store tank in a well ventilated area away from heat or open flame.

- Clean fuel filters. Refer to Maintenance Section, **FUEL FILTER**.
- Remove propeller and check for damage. If damaged, see your DEALER. Clean the propeller shaft and lubricate with *OMC Triple-Guard* grease. Refer to Maintenance Section, **PROPELLER**.
- Remove battery. Clean, check condition, and store battery in a cool dry place out of direct sunlight. Check water level and charge periodically.
- Drain and refill gearcase. Lubricate motor. Refer to Maintenance Section, **LUBRICATION**.
- Touch up paint. See your DEALER.
- Apply a coat of automotive wax to finished surfaces.
- Check motor for loose screws and nuts (torque as specified in service manual).
- Make sure spark plug boots, start solenoid terminal boot, and connector sleeves are in place.
- Check electrical and ignition systems for damaged parts or misplaced leads.
- Replace deteriorated or damaged fuel system parts.
- Reinstall engine cover.
- Motor must be stored in normal (vertical) position on stand or boat.

Note Do not place motor in a position where the gearcase will be higher than the powerhead. Any water remaining in the exhaust passages may run into the cylinders and cause serious damage.

⚠ Safety Warning: Failure to carefully reattach motor and control systems to boat with original specified hardware may result in sudden loss of boat control.

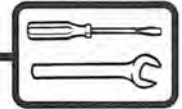

PRE-SEASON SERVICE

Before returning your motor to service proceed as follows:

- With propeller removed, check gearcase for leakage. If leakage is evident, gearcase seals may need attention. See your DEALER.
- Check condition of anti-corrosion anodes. Refer to **ANTI-CORROSION ANODES**.
- Connect spark plug leads. Refer to **SPARK PLUGS**
- Reinstall battery. Refer to Installation Section, **INSTALLING BATTERY**.
- After starting, check to see that a steady stream of water is discharged from the water pump indicator. This indicates proper water pump operation.
- If motor was removed from boat during storage, install motor. Refer to Installation Section, **INSTALLING MOTOR**.

 **Safety Warning:** Failure to carefully reattach motor and control systems to boat with original specified hardware may result in sudden loss of boat control.

- Fill fuel tank with fresh fuel mixture. Connect fuel line to motor.
- Install propeller. Do not install propeller if using a flushing attachment.

 **Safety Warning:** If you use a flushing attachment, run engine without propeller to prevent contact with rotating propeller.

- Start engine. Refer to Starting section, **STARTING**.

 **Safety Warning:** Do not use jumper cables and booster battery to start engine. Fumes vented can lead to explosion and fire.

- Check water pump indicator often. If no water is flowing from indicator refer to Operation Section, **OVERHEATING**.
- Stop engine and check for fuel leakage.

 **Safety Warning:** Failure to check for fuel leakage could lead to explosion and fire.

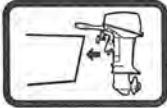
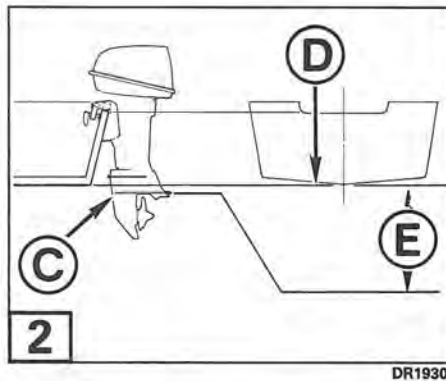
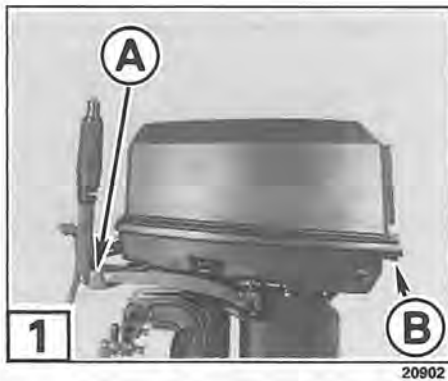

Installation	34
Mounting Requirements	34
Shaft Length	34
Installing Motor	35
Installing Battery	35

INSTALLATION

Important This motor should be installed by your DEALER. However, if you decide to install the motor, follow the instructions in this Section. You must obtain the appropriate OMC Service Manual to complete remote control and cable installation.

Mounting Requirements

Safety Warning:

- Do not overpower your boat by using an engine that exceeds the horsepower indicated on the boat's capacity plate. Overpowering could result in loss of control. If boat does not have a capacity plate, contact your DEALER or the boat's manufacturer.
- Incorrectly matched boat and motor transom heights can cause boat instability or loss of boat control.
- To prevent lateral movement and possible loss of motor, you must use the mounting hardware supplied with the motor.

Important The motor warranty will not cover product damage or failure that results from incorrect motor installation.

Shaft Length

Use the following procedure to determine that the motor is the correct shaft length for the boat.

- 1 Use the carrying handle **A** and lower rear engine cover **B** to lift motor.

Note DO NOT use tilt grip or steering handle to lift motor.

Place motor on center of transom and tighten clamp screws by hand.

- 2 Adjust motor angle so that the anti-ventilation plate **C** is parallel to the boat bottom. Refer to **MOTOR ANGLE ADJUSTMENT**.

- 2 The anti-ventilation plate **C** must not be higher than, nor more than 2" (51mm) below, the boat bottom **E**.

Note • If the anti-ventilation plate falls outside the 0 - 2" (0 - 51mm) range **E**, the installation is not considered normal. The motor shaft length must be changed or the boat transom must be modified.

- If you are installing this motor on a specialty, non-planing hull, these guidelines might not apply. See your DEALER for special installation information.

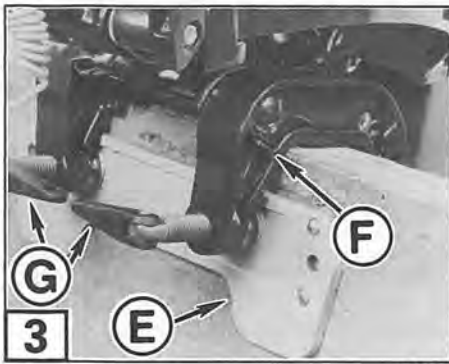

24192

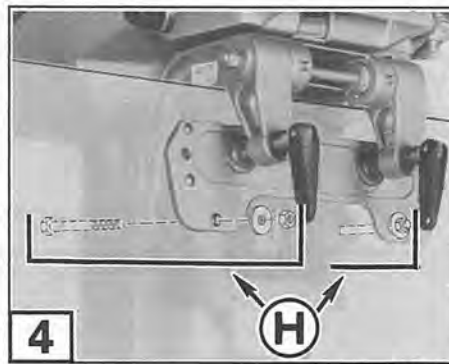

2231A

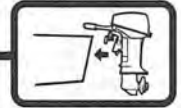

Installing Motor

- 3** Use an accessory transom plate **E** (not supplied) to protect the boat transom and help prevent loss of motor.

Note A motor retention lug **F** is provided to help prevent loss of motor. See your DEALER.

- 3** Place motor in center of transom and tighten clamp screws **G** by hand. DO NOT use tools to tighten clamp screws.

- 4** To prevent lateral movement of motor, bolt stern brackets to transom with the hardware **H** supplied.

- Use the stern brackets as a template to locate and drill two 5/16" (8mm) holes through the transom. Be sure to drill holes at right angles to the transom.
- Make sure that the installation will be watertight. Use waterproof caulking on bolt shanks and on washers inside the transom.
- Secure the motor to the transom with bolts, washers and locknuts as shown.

Note Retighten motor clamp screws after 15 minutes of operation. Check clamp screws on a regular basis.

Installing Battery

⚠ Safety Warning: Failure to ensure clean, tight electrical connections might result in sparks that can ignite fuel vapors under the engine cover.

This motor has a negative ground.

Important The BLACK battery cable must be connected to the negative (-) terminal on the battery. The RED battery cable must be connected to the positive (+) terminal on the battery.

Note If the battery cables are reversed, the charging unit will be damaged. DO NOT attempt to connect or disconnect any part of the electrical circuit while the motor is running.

Make sure that cable clamps are tight to ensure a good connection. Apply *OMC Triple-Guard*[®] grease to the exposed areas of the battery posts and cable clamps to reduce corrosion.

Make regular checks to ensure clean tight connections throughout the electrical system.